



KINEMATICA

Homogenizing perfected.

POLYTRON®



POLYTRON® SYSTEM PT 45-80 GT

Operating Manual

Translated Version

**Garantie
Warranty
Upgrade**











Jetzt registrieren / Register now:
kinematica.ch/garantie-upgrade
kinematica.ch/warranty-upgrade

System	POLYTRON®		
Typ	PT 45-80 GT		
Ausgabe	1.0 / 01.06.2019		
Seite	2	von	33







SAFETY INDICATIONS

Please pay attention to the meaning of the following warning signs:









	SAFETY INSTRUCTIONS MUST BE OBSERVED TO ENSURE SAFE OPERATION.
	THIS SYMBOL INDICATES HIGH VOLTAGE, WITH RISK TO HEALTH AND ENVIRONMENT.
	CAUTION! BEWARE OF HOT SURFACE.
	CAUTION! BEWARE OF HAZARDOUS CHEMICALS OR MATERIALS THAT ENDANGER HEALTH
	CAUTION! BEWARE OF ROTATING MECHANICAL PARTS.
	CAUTION! DEVICE NOT DESIGNED FOR USE IN EXPLOSION DANGER ENVIRONMENT.
	CAUTION! BEWARE OF MOVING PARTS. NEVER PUT YOUR HANDS OR FINGERS IN BETWEEN. CRUSHING HAZARD.
	CAUTION! DANGER BY PRESSURIZED PARTS
	CAUTION! RISK OF STUMBLING.

Operating Manual			
System	POLYTRON®		
Typ	PT 45-80 GT		
Ausgabe	1.0 / 01.06.2019		
Seite	3	von	33

GENERAL SAFETY INSTRUCTIONS





	RESPECT THE INSTRUCTIONS GIVEN IN THIS DOCUMENT.
	READ THESE OPERATING INSTRUCTIONS BEFORE SWITCHING ON OR OPERATING THE EQUIPMENT.
	IF YOU HAVE ANY QUESTIONS OR DOUBTS REGARDING OPERATING THE UNIT, DO NOT START OR OPERATE THE UNIT AND CONTACT YOUR DEALER OR NEAREST KINEMATICA SERVICE CENTER.
	IMPROPER USE OF THE MACHINE / UNIT DUE TO UNAUTHORIZED PERSONNEL CAN LEAD TO DAMAGE ON THE MACHINE / UNIT AND / OR ENDANGER LIFE, CAUSE PERSONAL INJURY AND HARM THE ENVIRONMENT.
	ALL AUTHORIZED PERSONNEL INVOLVED IN THE OPERATION, THE SERVICE OR THE REPAIR OF THE UNIT HAVE TO READ AND TO UNDERSTAND THIS MANUAL.
	ONLY AUTHORIZED PERSONNEL / INTENDED USERS ARE ALLOWED TO USE THE MACHINE.
	THE INTENDED USER ASSURES THAT THE MACHINE / UNIT WILL BE INSTALLED CORRECTLY IN ORDER TO FULFILL THE INTENDED APPLICATION AND AUTHORIZES OTHER QUALIFIED USERS TO WORK WITH THE UNIT. HE IS ALSO RESPONSIBLE TO INSTRUCT THE USERS OF THE UNIT.

System	POLYTRON®		
Typ	PT 45-80 GT		
Ausgabe	1.0 / 01.06.2019		
Seite	4	von	33

	THE SERVICE ENGINEER IS EMPLOYED BY THE INTENDED USER AND MAINTAINS THE UNIT DURING OPERATION. HE IS A SKILLED CRAFTSMAN WITH MECHANICAL, ELECTRICAL AND ELECTRONIC EDUCATION. THE SERVICE ENGINEER IS RESPONSIBLE FOR THE INSTALLATION AND START-UP OF THE UNIT AS WELL AS FOR THE MAINTENANCE AND REPAIR OF THE UNIT. HE MUST BE TRAINED ACCORDINGLY TO CARRY OUT ALL NECESSARY MAINTENANCE WORK.
	ENSURE THAT ALL LEGAL AND ENVIRONMENTAL REGULATIONS OF THE COUNTRY WHERE THE UNIT WILL BE INSTALLED ARE FOLLOWED.
	DO NOT MODIFY THE UNIT WITHOUT A WRITTEN CONFIRMATION BY KINEMATICA.
	IT IS STRICTLY FORBIDDEN TO RUN THE MACHINE / UNIT WITH DISASSEMBLED OR BRIDGED SAFEGUARDS, FOR EXAMPLE SAFETY LIMIT SWITCH, EMERGENCY SWITCH OR COVER.
	FOR REPAIRS, ONLY ORIGINAL SPARE PARTS SHOULD BE USED.
	BEFORE STARTING INSPECTION AND MAINTENANCE WORK ON THE UNIT (SERVICE, REPAIR ETC.), ALL POWER SUPPLIES MUST BE DISCONNECTED.
	THE DRIVE UNIT MAY ONLY BE OPENED BY AUTHORIZED KINEMATICA SERVICE STATIONS.
	SERVICE AND MAINTENANCE SHALL ONLY BE PERFORMED BY AUTHORIZED AND SKILLED SERVICE ENGINEERS.







Operating Manual

System	POLYTRON®		
Typ	PT 45-80 GT		
Ausgabe	1.0 / 01.06.2019		
Seite	5	von	33









	AFTER EVERY INSPECTION AND MAINTENANCE WORK ON THE MACHINE / UNIT (SERVICE, REPAIR ETC.) THE SERVICE ENGINEER HAS TO DO A TEST-RUN.
	EAR PROTECTION SHOULD ALWAYS BE USED WHEN WORKING IN THE ENVIRONMENT OF THE UNIT.
	KEEP THIS OPERATING MANUAL NEARBY THE EQUIPMENT FOR FUTURE REFERENCE.
	THIS DOCUMENT IS PART OF THE UNIT AND SHOULD NOT BE REMOVED OR STORED ELSEWHERE. EASY ACCESS TO THE OPERATING AND MAINTENANCE CREW MUST BE GRANTED AT ALL TIMES.
	ALTHOUGH POLYTRON® UNITS ARE DESIGNED FOR EASY USE, THIS DOES NOT RELEASE YOU FROM THE OBLIGATION TO INSPECT YOUR EQUIPMENT CAREFULLY AND TO CLEAN IT THOROUGHLY.

System	POLYTRON®		
Typ	PT 45-80 GT		
Ausgabe	1.0 / 01.06.2019		
Seite	6	von	33







WARNINGS

	ALL WARNINGS AND RECOMMENDATIONS IN THIS DOCUMENT MUST BE RESPECTED.
	THE EQUIPMENT MAY NOT BE OPERATED IN EXPLOSIVE AREAS. IT IS NOT ALLOWED TO WORK WITH FLUIDS WHICH ARE HIGHLY INFLAMMABLE. IT IS NOT ALLOWED TO MIX MATERIALS WHICH CAN CAUSE STRONG EXOTHERMAL REACTIONS
	THE ELECTRICAL INSTALLATION MUST BE DONE BY A QUALIFIED ELECTRICIAN !
	ENSURE THAT THE RATED VOLTAGE OF THE EQUIPMENT MATCHES THE SUPPLY. IT IS IMPORTANT THAT THE MAINS SUPPLY WHERE THE DEVICE IS PLUGGED IN COMPLIES WITH THE INFORMATION ON THE TYPE LABEL AND THE INTERNATIONAL STANDARDS FOR POWER SUPPLIES. IF NOT, SUCCESSFUL OPERATION CANNOT BE GUARANTEED.
	THE UNIT MUST BE PLACED PLANAR ON A SUITABLE WORKING AREA.
	ENSURE THAT ENOUGH FREE SPACE IS AVAILABLE AROUND THE UNIT, SO THAT EFFECTIVE AIR FLOW AND COOLING IS ASSURED. INSUFFICIENT COOLING MAY LEAD TO A DECREASE OF POWER OUTPUT AND OVERHEATING.
	THE DEVICE HAS TO BE PLACED IN A MANNER THAT DIRT OR FLUIDS CANNOT PENETRATE THROUGH THE VENTILATION SLOTS AT BACK SIDE OF THE DRIVE.









System	POLYTRON®		
Typ	PT 45-80 GT		
Ausgabe	1.0 / 01.06.2019		
Seite	7	von	33

	DRY-RUN OF THE SLIDE BEARING OF THE DISPERSING AGGREGATE (ABOVE THE GENERATOR) MUST BE AVOIDED. THE SLIDE BEARING HAS TO BE LUBRICATED BY THE PRODUCT DURING OPERATION.
	THE OPERATOR / INTENDED USER HAS TO ENSURE THAT THE UNIT WILL ONLY BE STARTED WHEN THE INTENDED PROCESS VESSEL IS SECURELY FIXED IN THE RIGHT POSITION, THE PROCESS VESSEL IS FILLED WITH APPROPRIATE PRODUCT AND THE DISPERSING AGGREGATE IS PROPERLY IMMERSSED IN THE PRODUCT.
	THE MAX. OPERATIONAL SPEED IS INDICATED ON THE DATA PLATE
	THE INTENDED USER HAS TO ENSURE THAT NO FOREIGN PARTICLES / BODIES WHICH MIGHT LEAD TO A DAMAGE CAN PASS THROUGH THE UNIT OR FALL INTO THE PROCESS VESSEL.
	THE ASSEMBLY AND DISASSEMBLY PROCEDURE IS DESCRIBED IN THIS MANUAL. THE UNIT IS ONLY ALLOWED TO BE OPERATED WHEN ASSEMBLED COMPLETELY
	NEVER REMOVE ANY COMPONENTS OR REMOVE CONNECTIONS OF THE UNIT DURING OPERATION.
	NEVER PULL THE COUPLING DURING OPERATION - THE AGGREGATE COULD FALL OUT OF THE COUPLING.
	THE RESPONSIBILITY OF KEEPING THE OPERATING PARAMATERS SUCH AS PRESSURE, TEMPERATURE, SPEED AND PRODUCT FLOW WITHIN THE SPECIFIED LIMITS LIES WITH THE INTENDED USER. IN CASE OF HIGH PRESSURE AND / OR HIGH TEMPERATURE (IF PERMITTED) THE INTENDED USER HAS TO INSTALL PROPER PROTECTIVE COVERS.

System	POLYTRON®		
Typ	PT 45-80 GT		
Ausgabe	1.0 / 01.06.2019		
Seite	8	von	33



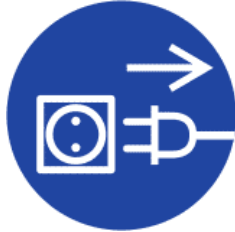

	NEVER PUT ANY PRESSURE OR VACUUM TO A SYSTEM OR TO PARTS OF IT WHICH ARE NOT DESIGNED FOR SUCH OPERATION. SEE ALSO TECHNICAL DATA AND LIMITATIONS.
	IN THE EVENT THAT HAZARDOUS CHEMICALS OR MATERIALS THAT ENDANGER HEALTH CAN INFLUENCE THE SURROUNDINGS OR USE OF THE EQUIPMENT, APPROPRIATE COUNTERMEASURES MUST BE TAKEN.
	WHEN HANDLING DANGEROUS PRODUCTS, TAKE CARE THAT THE LOCAL SAFETY REGULATIONS ARE RESPECTED.
	AT LONG TERM USE AND HEAVY DUTY LOAD THE COUPLING AT THE DRIVE UNIT AND DISPERSING AGGREGATE MAY GET HOT - DANGER OF SKIN BURN
	NEVER TOUCH ANY ROTATING OR COUPLING PARTS AS LONG AS THE MACHINE IS UNDER OPERATION OR CONNECTED TO MAINS SUPPLY - DANGER OF HEAVY INJURIES.
	AFTER A POWER BLACKOUT OR THE USE OF THE MAIN SWITCH DURING OPERATION (OFF/ON) THE DRIVE UNIT WILL NOT START AUTOMATICALLY. THE SPEED KNOB HAS TO BE TURNED TO ZERO-POSITION FIRST. THEN THE SPEED LEVEL CAN BE AGAIN SET USING THE SPEED KNOB.
	IF THE MACHINE / UNIT IS USED FOR ANY OTHER PURPOSE THAN THE INTENDED APPLICATION OR IF THE MACHINE / UNIT WILL BE OPERATED BEYOND THE TECHNICAL DATA RANGE WITHOUT THE WRITTEN APPROVAL BY KINEMATICA, IMPROPER USE IS DECLARED AND KINEMATICA WILL TAKE NO RESPONSIBILITY, NOR WILL GRANT ANY GUARANTEE. IMPROPER USE OF THE MACHINE / UNIT CAN RESULT IN PERSONAL INJURY OR IN DAMAGE OF THE EQUIPMENT. KINEMATICA WILL NOT BE LIABLE AND WILL TAKE NO RESPONSIBILITY IN SUCH AN EVENT.

System	POLYTRON®		
Typ	PT 45-80 GT		
Ausgabe	1.0 / 01.06.2019		
Seite	9	von	33

	THE UNIT SHOULD BE CLEANED AFTER EVERY OPERATION.	
	IF THE PROCESSED MEDIA TENDS TO HARDEN OR STICK, THE DISPERSING AGGREGATE HAS TO BE CLEANED COMPLETELY AFTER EVERY RUN.	
	PAY ATTENTION THAT THE TEMPERATURE DIFFERENCE BETWEEN ACTUAL TEMPERATURE OF THE SYSTEM / PROCESS VESSEL AND CLEANING TEMPERATURE IS KEPT TO A MINIMUM.	
	A TEMPERATURE SHOCK CAN DAMAGE STRUCTURAL COMPONENTS.	
	THE INTENDED USER HAS TO ENSURE THAT USED SOLVENTS AND CLEANING MATERIALS ARE COMPATIBLE WITH THE MATERIAL OF THE SEALS AND COMPONENTS OF THE UNIT.	
	WHEN REPLACING AN DISPERSING AGGREGATE THE LINE CORD HAS TO BE DISCONNECTED FROM THE POWER SUPPLY	
	BEFORE PUSHING UP THE SLIDER OF THE QUICK COUPLING AT THE DRIVE UNIT, HOLD THE DISPERSING AGGREGATE IN ONE HAND AVOIDING THE DISPERSING AGGREGATE TO FALL DOWN UNCONTROLLED.	
	ALL MAINTENANCE WORK HAS TO BE DONE BY SPECIALISTS OR ENGINEERS.	

Operating Manual









System	POLYTRON®		
Typ	PT 45-80 GT		
Ausgabe	1.0 / 01.06.2019		
Seite	10	von	33

	BEFORE STARTING THE DISASSEMBLY, ALL ELECTRICAL PARTS HAVE TO BE DISCONNECTED.
	MAKE SURE THAT THE MOTOR CANNOT BE STARTED FROM ANOTHER PERSON, WHILE YOU ARE WORKING
	BE AWARE OF SHARP EDGES AND TEETH AT ROTOR AND STATOR WHEN DISASSEMBLING / ASSEMBLING DISPERSING AGGREGATES – DANGER OF CUT-INJURIES
	CRANES AND/OR LIFTING EQUIPMENT MUST BE USED TO MOVE AND TRANSPORT HEAVY EQUIPMENT.
	ALL PARTS HAVE TO BE INSPECTED FOR SIGNS OF WEAR AND DAMAGE. IF NECESSARY, THEY HAVE TO BE REPLACED.

System	POLYTRON®		
Typ	PT 45-80 GT		
Ausgabe	1.0 / 01.06.2019		
Seite	11	von	33

RESIDUAL DANGERS

When the system/equipment is used in accordance with rules and regulations, residual dangers are minimal.

Restgefahren	Gegenmassnahmen
 Tripping over feed or re-turn or supply lines, piping	These should be laid appropriately.
 Breakage of piping, vessels	Wear protective clothing (goggles etc.).  
  Leakage of product or other supply	
 Hearing loss due to loud noise.	According to the application ear protection must be used. 
 Tilting of the device	Use stable, non-slip base

Operating Manual			
System	POLYTRON®		
Typ	PT 45-80 GT		
Ausgabe	1.0 / 01.06.2019		
Seite	12	von	33

INHALT:

1	INTRODUCTION	13
1.1	RANGE OF VALIDITY	14
1.2	MANUFACTURER AND CONTACT ADDRESS	14
2	DESCRIPTION OF THE UNIT	15
2.1	OVERVIEW	15
2.2	POLYTRON® SYSTEM PT 45-80 GT	16
2.3	DRIVE UNIT PT 45-80 GT	17
2.4	STANDS	19
2.5	POLYTRON® DISPERSING-AGGREGATES	20
2.6	DISPERSING VESSELS	22
3	INSTALLATION AND START-UP	24
3.1	UNPACKING	24
3.2	MECHANICAL INSTALLATION	24
3.3	ELECTRICAL INSTALLATION	24
3.4	START-UP	25
3.5	SHUT-DOWN	25
4	MAINTENANCE WORK	26
4.1	DRIVE UNIT	26
4.2	CLEANING AND MAINTENANCE OF DISPERSING-AGGREGATES	27
5	TROUBLE SHOOTING	30
6	ACCESSORIES	31
7	WARRANTY	32
8	DISPOSAL	33

Operating Manual			
System	POLYTRON®		
Typ	PT 45-80 GT		
Ausgabe	1.0 / 01.06.2019		
Seite	13	von	33

1 INTRODUCTION

Kinematica is a specialist for design and manufacturing of dispersing and mixing devices, machines and plants. The aim of this document is to instruct new users in the effective and safe utilization of our equipment.

The Kinematica batch homogenizing system POLYTRON® PT 45-80 GT has been designed and manufactured according the Low-Voltage-Guideline for Laboratory Devices (2014/35/EU, EN 61010-1), the EMC-Guideline for Laboratory Devices (2014/30/EU, EN 61326-1), as well as the RoHS-Guideline, carries the CE mark and will be delivered with an according declaration of conformity.

This document is valid for the Kinematica laboratory batch homogenizing system POLYTRON® PT 45-80 GT.

The intended use of the lab system consists of:

- Batch processing (homogenizing, dispersing, mixing, stirring) of flowable and pumpable products under the considerations and limitations of the "Technical Data".
- The processed media must be compatible with all constructional parts wetted by the product.
- If suitable precautions to personnel are taken to prevent any harm due to noise emission.
- The use of the system with no structural, mechanical or electrical changes different from the original scope of supply.
- If the unit is hold by a stand or built onto a process vessel, so that the dispersing aggregate is immersed into the product and the dispersing generator (mixing head) does not touch the vessel wall or bottom.
- If the arrangement of the vessel and the unit (or through appropriate safety measurements) prevents the user or a person to touch the dispersing generator (mixing head) during operation.

Typical applications:

- preparing emulsions and suspensions
- pharmaceutical or cosmetics products
- suspending solids in liquids (such as liquid polymers)
- dispersing fine solids in liquids or molten phases
- suspending additives and solid polymers in mineral oils
- extracting enzymes from biomass
- extracting active ingredients and substances from plants
- grinding and shredding of solids and fibers in liquids or polymers

If the system is used for purposes different than or over and above the capabilities specified herein, KINEMATICA does not guarantee proper function and assumes no obligation or liability.

Operating Manual

System	POLYTRON®		
Typ	PT 45-80 GT		
Ausgabe	1.0 / 01.06.2019		
Seite	14	von	33

Improper use of the unit can cause injuries and/or system damage. KINEMATICA does not take responsibility or give any guarantees in such cases. Follow the instructions of this Kinematica manual.

Should you have any questions which are not answered in this document, please contact KINEMATICA.

Check on www.kinematica.ch for your closest contact address.

1.1 RANGE OF VALIDITY

The information in these operating instructions relates to the POLYTRON® laboratory unit identified as follows:

Manufacturer: KINEMATICA AG, CH-6014 Luzern
 Brand Name: POLYTRON®
 Product name: POLYTRON® PT 45-80 GT

Order No.	Identification
11010130	Drive unit POLYTRON® PT 45-80 GT, 230 V, with power cable with EU plug
11010131	Drive unit POLYTRON® PT 45-80 GT, 230 V, with power cable with CH plug
11010132	Drive unit POLYTRON® PT 45-80 GT, 230 V, with power cable with UK plug
11010133	Drive unit POLYTRON® PT 45-80 GT, 115 V, with power cable with US plug
11035001	Adapter for PT-DA / PTA dispersing aggregate
11040052	Plate stand ST-P21/700
11040036	Electrical stand ST-P14/590+500 (230V, EU plug)
11040033	Electrical stand ST-P14/590+500 (230V, CH plug)
11040037	Electrical stand ST-P14/590+500 (230V, UK plug)
11040034	Electrical stand ST-P14/590+500 (115V, US plug)

1.2 MANUFACTURER AND CONTACT ADDRESS

KINEMATICA AG

Luzernerstrasse 147a
 CH-6014 Luzern

TEL.: +41 41 259 65 65
 FAX: +41 41 259 65 75
 E-Mail: laboratory@kinematica.ch

Operating Manual			
System	POLYTRON®		
Typ	PT 45-80 GT		
Ausgabe	1.0 / 01.06.2019		
Seite	15	von	33

2 DESCRIPTION OF THE UNIT

2.1 OVERVIEW

The POLYTRON® System PT 45-80 GT is designed for the use in the laboratory. Working volumes up to 30'000 ml (depending on the viscosity of the product and the dispersing aggregate used) can be handled, producing e.g. finest dispersions and homogenisations.

The drive unit can be equipped with a wide range of POLYTRON® Dispersing Aggregates. The aggregates are easy to change using the quick-coupling.

Using the adapter (order no.: 11095000, optional) also PTA Dispersing Aggregates of the former model (System PT-G, drive unit PT 45-80) can also be equipped.

For a ready-to-use system you need:

- A drive unit POLYTRON® PT 45-80 GT
- A stand (to be ordered separately)
- A POLYTRON® Dispersing Aggregate (to be ordered separately)
- A dispersing vessel (to be ordered separately)

On the following page a picture of a complete system PT 45-80 GT incl. description of the main components can be found.

Operating Manual

System	POLYTRON®		
Typ	PT 45-80 GT		
Ausgabe	1.0 / 01.06.2019		
Seite	16	von	33

2.2 POLYTRON® SYSTEM PT 45-80 GT

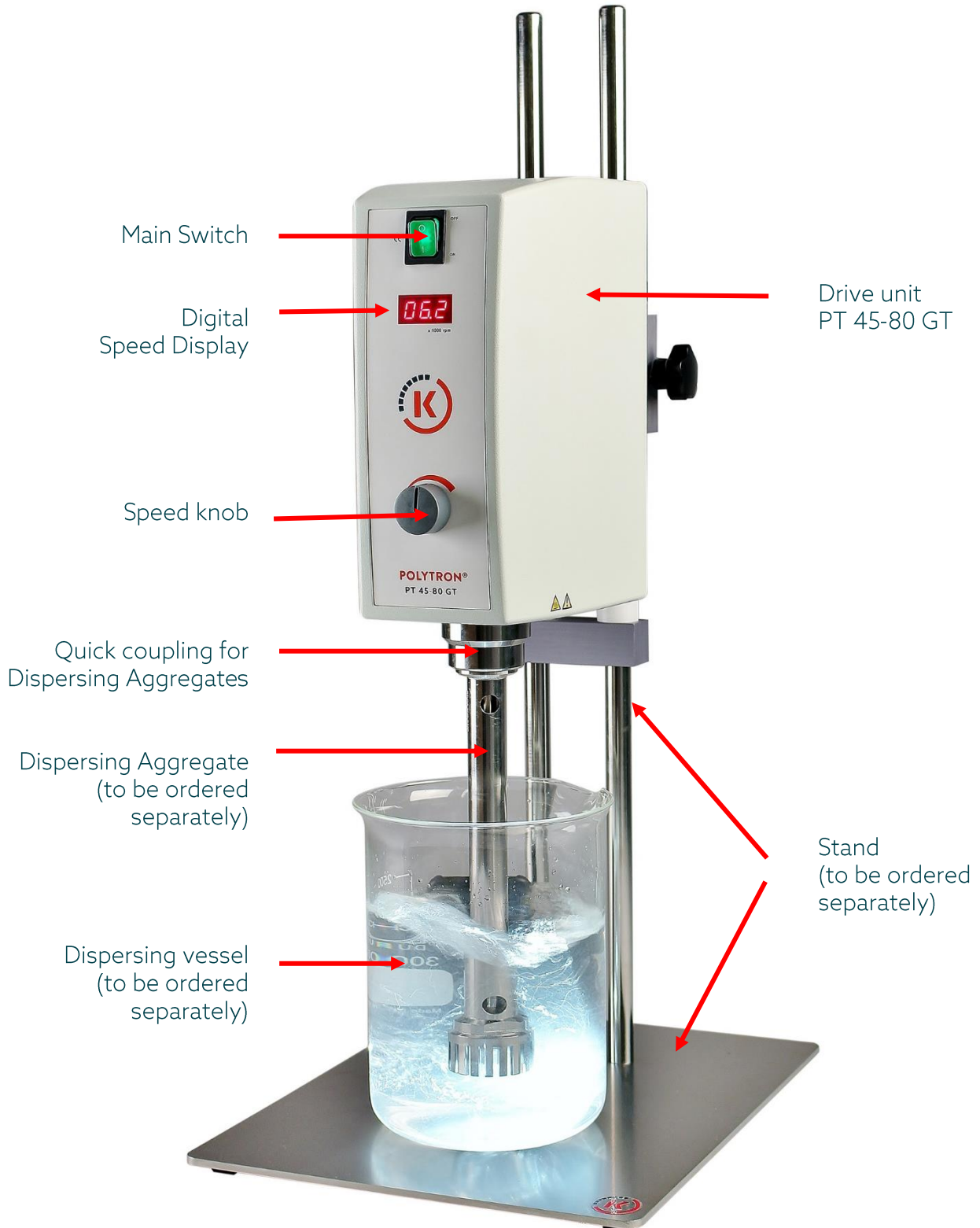

System	POLYTRON®		
Typ	PT 45-80 GT		
Ausgabe	1.0 / 01.06.2019		
Seite	17	von	33

2.3 DRIVE UNIT PT 45-80 GT

The drive unit PT 45-80 GT is equipped with a powerful 1'700 W DC brush motor and will be started using the main switch placed at the front side. The unit includes an integrated closed loop speed control electronic which allows for constant speed levels up to approx. 21'000 rpm at max. 1700 W, independent from load changes. The actual speed will be adjusted using the speed knob on the front side of the device and can be read from the digital display (LED).

Furthermore the electronic control system is equipped with safety functions with automatic stop in case of overheating or blocking including acoustic signals. A detailed description of possible errors and counter measurements is listed in chapter „TROUBLE SHOOTING“.

2.3.1 QUICK COUPLING

Due to the quick coupling (type F), POLYTRON® Dispensing Aggregates can be fitted to the drive unit and replaced very easily. The three pictures below show the mounting of an aggregate.

For easy mounting, the crown head of the aggregate and the coupling should be free of dirt.

Push the slider of the coupling upwards, at the same time push the aggregate into the coupling.

Push the aggregate upwards and at same time twist it a little until it has snapped in and the slider returns downwards

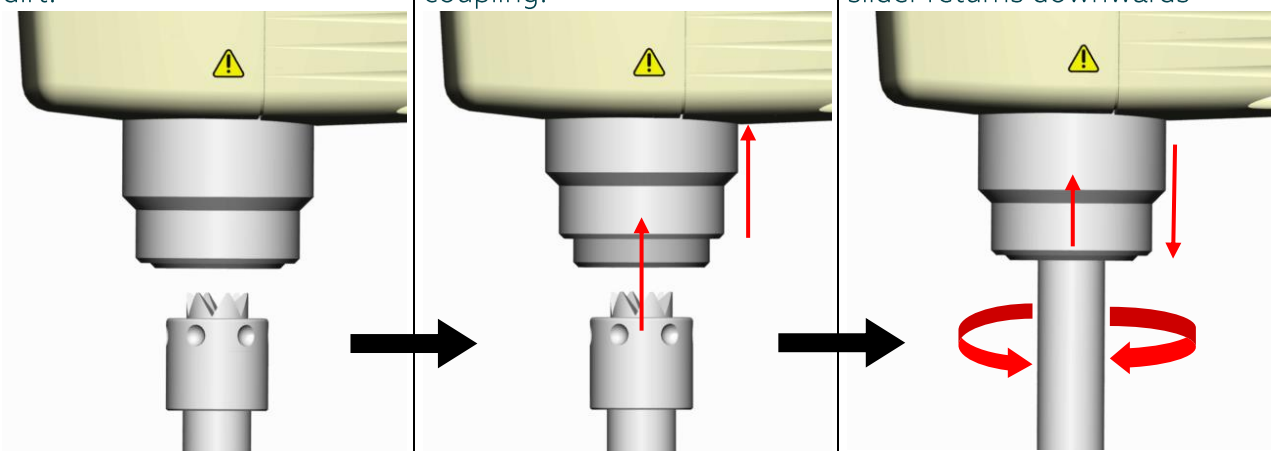

To remove the aggregate, proceed in reverse direction. Push the slider upwards and remove the dispersing aggregate from the coupling downwards.





CAUTION !:

BEFORE PUSHING UP THE SLIDER OF THE COUPLING, HOLD YOUR DISPERSING AGGREGATE IN ONE HAND AVOIDING THE AGGREGATE TO FALL DOWN WHEN PUSHING UP THE SLIDER.

Operating Manual

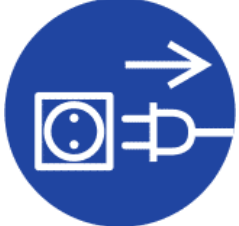
System	POLYTRON®		
Typ	PT 45-80 GT		
Ausgabe	1.0 / 01.06.2019		
Seite	18	von	33

	<p>CAUTION! WHEN REPLACING AN AGGREGATE THE LINE CORD HAS TO BE DISCONNECTED FROM THE POWER SUPPLY</p>	
	<p>CAUTION! AT LONGTERM USE AT HIGH LOADS, THE AGGREGATE & THE COUPLING CAN HEAT UP TO HIGH TEMPERATURE LEVELS – DANGER OF SKIN BURN.</p>	

2.3.2 TECHNICAL DATA

Drive unit PT 45-80 GT	
Motor type	Universal DC brush motor
Supply voltage	230 V ~ 100/115 V ~
Supply frequency	50/60 Hz
Max. current	Ca. 8 A ca. 16 A
Max. speed	21'000 rpm
Speed indication	LED (3 digit)
Speed measurement	Digital, direct by HAL-probe (no calibration needed)
Max. input power	approx. 1700 W
Max. output power	approx. 1200 W
Softstart	Yes
Noise emission (drive only)	approx. 85 dB(A) at 21'000 min ⁻¹
Direction of rotation	clockwise, seen from above
Ambient temperature	0 - 40°C
Relative humidity	max. 95%
Certified standards	EMC acc. IEC/EN 61000-6-2 / EN 61000-6-3 Safety acc. IEC/EN 61010-2-51
Protection type	IP 20
Max. period of continuous operation	depending on load & speed 100 % duty time is possible
Dimensions (WxDxH)	140x240x305 mm
Weight	6.8 kg (drive unit only)

Operating Manual

System	POLYTRON®		
Typ	PT 45-80 GT		
Ausgabe	1.0 / 01.06.2019		
Seite	19	von	33

2.4 STANDS

The drive PT 45-80 GT is designed for using with a stand.
The following stands can be used as standard:

Plate Stand
ST-P21/700



Electrical Stand
ST-P14/590+500



System	POLYTRON®		
Typ	PT 45-80 GT		
Ausgabe	1.0 / 01.06.2019		
Seite	20	von	33

2.5 POLYTRON® DISPERSING-AGGREGATES

A wide range of dispersing aggregates with diameters from 5 to 60 mm are available. All dispersing aggregates of type Typ POLYTRON® PT-DA xx/yy EC-Fzzz (e.g. PT-DA 45/2 EC-F250) can be used.

The below illustration shows the different parts of a POLYTRON® Dispersing Aggregate.

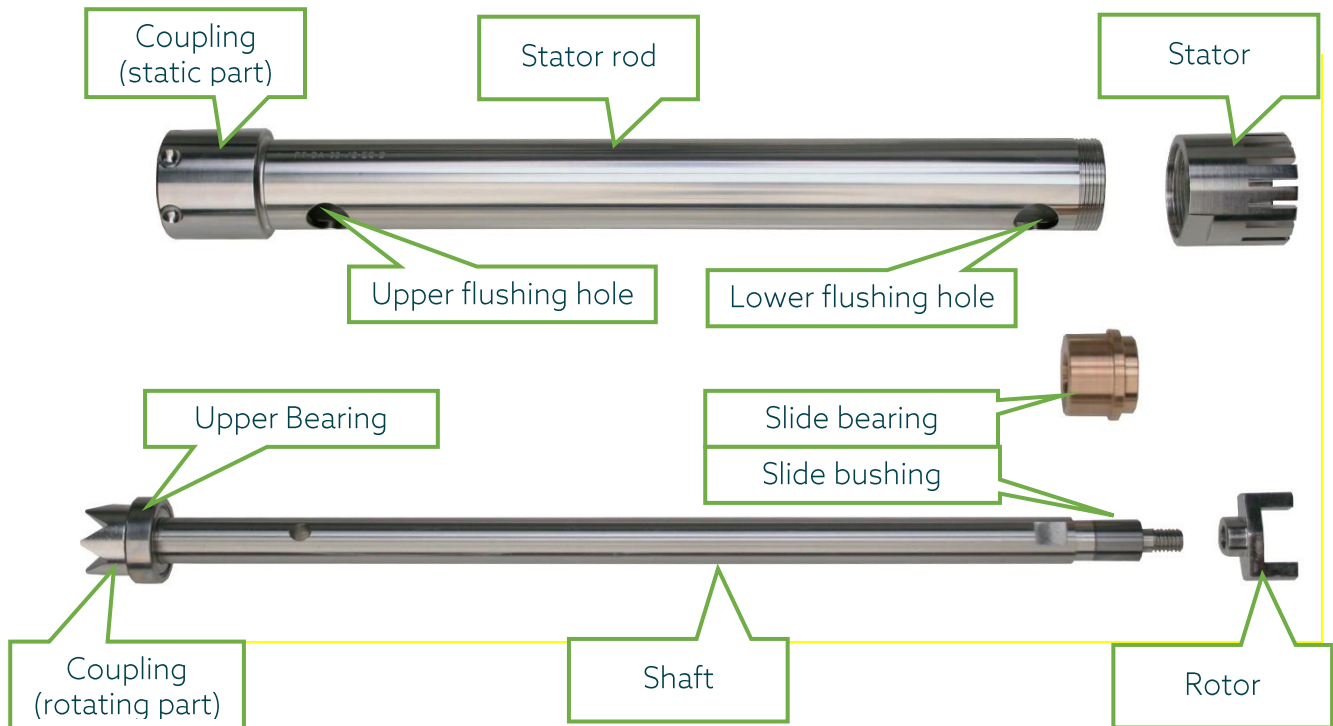

For questions concerning choosing and use of POLYTRON® dispersing aggregates please get in contact with KINEMATICA or your local specialist dealer.

System	POLYTRON®		
Typ	PT 45-80 GT		
Ausgabe	1.0 / 01.06.2019		
Seite	21	von	33

2.5.1 DISPERSING GENERATORS

The dispersing generator is positioned at the head of the dispersing aggregate. The dispersing generator consists of a Rotor and a Stator. Depending on the application Rotor and Stator consists of one or more teeth rows with specific teeth shapes and fineness.



Turning with high speed the rotor creates inside the stator high mechanical shear forces and shear stress resulting in size reduction and turbulent mixing of the processed media.

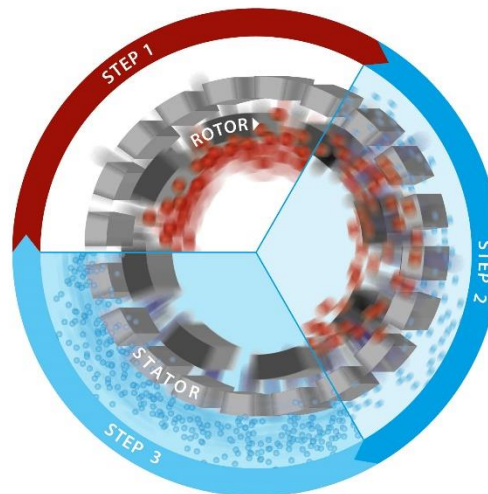

Dispersing generators (> Ø 30 mm) are screwed to the dispersing aggregate and can be exchanged.

Please bear in mind due to operation the dispersing generator(s) belong to the wear and tear parts.

Operating Manual

System	POLYTRON®		
Typ	PT 45-80 GT		
Ausgabe	1.0 / 01.06.2019		
Seite	22	von	33

2.6 DISPERSING VESSELS

The appropriate dispersing vessel completes the dispersing system. The drive unit is only allowed to be operated and started if the chosen dispersing aggregate is correctly coupled to the drive unit and if the dispersing aggregate is immersed properly into the product media filled in the dispersing vessel.

Following general remarks:

- The dispersing vessel has to be secured and fixed against unintended moving or tipping during operation.
- The dispersing vessel, the product to be processed and the chosen dispersing aggregate should be fitting to each other to allow for an optimum processing.
- A round vessel facilitates the build-up of a vortex which can lead to less good mixing results. Kinematica offers a range of special dispersing vessels for an optimal homogenisation.
- The dispersing aggregate must be immersed into the product so that the slide bearing and the lower flushing holes respectively are below the liquid level as a minimum. The upper flushing holes are not allowed to be immersed into the product.
- As the dispersing aggregate and the dispersing generator respectively sucks in the product from below, the positioning of the generator just above or on the ground of the vessel has to be avoided.
- Depending on the product and application a positioning of the dispersing generator within the vessel at 1/3 of the filling height is recommendable.

Operating Manual

System	POLYTRON®		
Typ	PT 45-80 GT		
Ausgabe	1.0 / 01.06.2019		
Seite	23	von	33

For questions concerning choosing and use of the appropriate dispersing vessel please get in contact with KINEMATICA or your local specialist dealer.



Operating Manual			
System	POLYTRON®		
Typ	PT 45-80 GT		
Ausgabe	1.0 / 01.06.2019		
Seite	24	von	33

3 INSTALLATION AND START-UP

3.1 UNPACKING

Open the transport box and check that the contents agrees with the delivery note.

	<p>CHECK ALL PARTS FOR POSSIBLE TRANSPORT DAMAGE. INFORM US OR YOUR DEALER IMMEDIATELY ABOUT ANY DISAGREEMENT OR FAULT. IF POSSIBLE SEND US DIGITAL PHOTOS BY EMAIL TO LABORATORY@KINEMATICA.CH</p>
---	---

3.2 MECHANICAL INSTALLATION

- The drive unit is completely assembled and has to be fixed to a suitable stand (to be ordered separately). The assembly of the stand and the mounting of the drive unit to the stand is described in the assembly instructions of the stand.
- The POLYTRON® unit (drive and stand) has to be evenly and vibration-free placed on a suitable, flat working area. No vibrations are allowed to be transmitted onto the unit. Sufficient air circulation must be assured.
- Connect a chosen POLYTRON® Dispensing Aggregate (to be ordered separately) to the drive unit by means of the F-Quick coupling at the drive as described above.
- An appropriate and suitable dispersing vessel has to be installed and fixed below the dispersing aggregate.

3.3 ELECTRICAL INSTALLATION

	<p>ALLE ELEKTROARBEITEN DÜRFEN NUR VON AUTORISIERTEN PERSONEN DURCHGEFÜHRT WERDEN. ANSCHLUSSDATEN SIEHE SPEZIFIKATION UND ELEKTRISCHE TYPENSCHILDER.</p>
---	--



- The mains cable (included in scope of supply) has to be plugged into the drive unit on its backside. The mains plug to be connected to a suitable power socket / power supply by customers.

Operating Manual

System	POLYTRON®		
Typ	PT 45-80 GT		
Ausgabe	1.0 / 01.06.2019		
Seite	25	von	33

3.4 START-UP

- Immerse the dispersing aggregate into the product properly. For this purpose lift/lower the drive unit by using the stand.
 - Note: In some cases it can be advantageous to place the vessel excentric in order to get more turbulences for better mixing of the product.
- Switch on the unit by using the main switch.
- Set the appropriate speed level by using the speed knob. The actual speed is shown on the digital display.

	POLYTRON® DISPERSING AGGREGATES MAY NOT BE OPERATED DRY – THE SLIDE BEARING IS COOLED AND LUBRICATED BY THE MEDIUM BEING PROCESSED. RUNNING DRY WILL DESTROY THE SLIDE BEARING.
	NEVER TOUCH A ROTATING PART OF A DISPERSING AGGREGATE – DANGER OF SEVERE CUT-INJURIES.
	NEVER USE THE QUICK COUPLING DURING OPERATION.

3.5 SHUT-DOWN

- Turn the speed knob to „Zero“ position to stop the drive unit.
- Turn off the drive unit by using the main switch.

	THE DISPERSING AGGREGATES SHOULD BE CLEANED THOROUGHLY AFTER EVERY OPERATION.
---	---

4 MAINTENANCE WORK

Your POLYTRON unit is designed for easy servicing. Nevertheless, it is essential to inspect your equipment carefully and to clean it thoroughly.

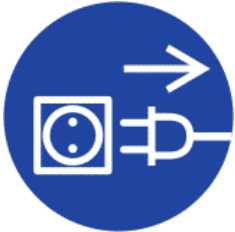
	<p>THE EQUIPMENT MUST BE DIS-CONNECTED FROM THE ELECTRICAL SUPPLY:</p> <ul style="list-style-type: none"> • DURING ANY WORK ON THE EQUIPMENT, IN ORDER TO AVOID ANY PERSONAL INJURY OR OTHER DAMAGE • WHEN CHANGING OR REMOVING THE DISPERSING AGGREGATE 	
---	--	---

4.1 DRIVE UNIT

Under normal working conditions, the PT 3100 D drive requires no servicing. Parts such as the motor brushes and bearings are subject to natural wear.

The following are standard values for wear parts of the drive:

- bearing: several 1000's of operating hours.
- brushes: Approx. 150 hours of operating at rated power.

We strongly recommend that service work and repairs should be carried out only by authorized KINEMATICA service centres or by KINEMATICA directly, where original replacement parts are available.

For cleaning the housing and any other outside surface please assure that the cleaning agent is in compliance with the following materials:

- Polyamide (housing and membrane keyboard)
- Stainless steel 304 / 316 L
- Aluminium

Any unauthorised modification or manipulation of the unit or its equipment leads to immediate annulment of the warranty.

System	POLYTRON®		
Typ	PT 45-80 GT		
Ausgabe	1.0 / 01.06.2019		
Seite	27	von	33

4.2 CLEANING AND MAINTENANCE OF DISPERSING-AGGREGATES

EC-aggregates, (EC stands for EASY CLEAN) are easy to disassemble and clean. With some restrictions (*) they can be sterilised in an autoclave by several methods. In the following three chapters the de/assembling procedures will be described.

(*) Depending on the frequency and the intensity of the sterilisation process, the life span of the bearings may be reduced due to loss of grease during evacuation in an autoclave.



CAUTION!
BE AWARE OF SHARP EDGES AND TEETH WHEN DE/ ASSEMBLING
AGGREGATES – DANGER OF CUT-INJURIES

4.2.1 Disassembly of Dispersing-Aggregates with Ø5 und Ø7 mm

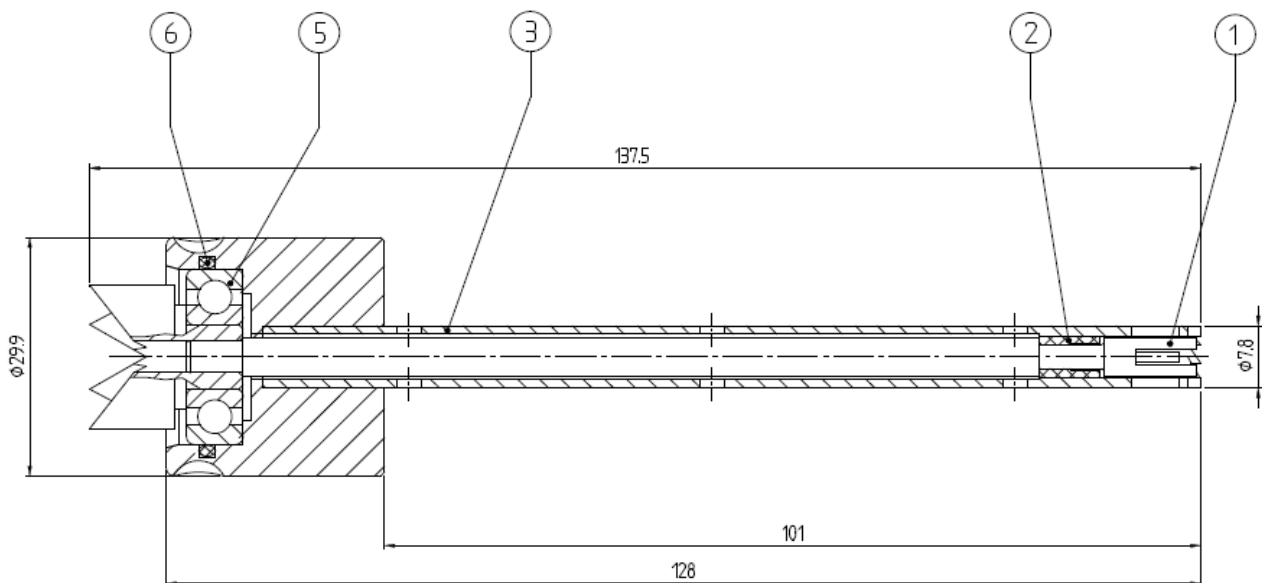

1. Push the shaft (1) from the right side out of the stator pipe.
2. Remove the slide bearing (2) from the shaft.
3. Remove the o-ring(6).
4. After the cleaning process, reassemble the aggregate in reverse order.



System	POLYTRON®		
Typ	PT 45-80 GT		
Ausgabe	1.0 / 01.06.2019		
Seite	28	von	33

4.2.2 Disassembly of Dispersing-Aggregates with $\varnothing 12$ und $\varnothing 20$ mm

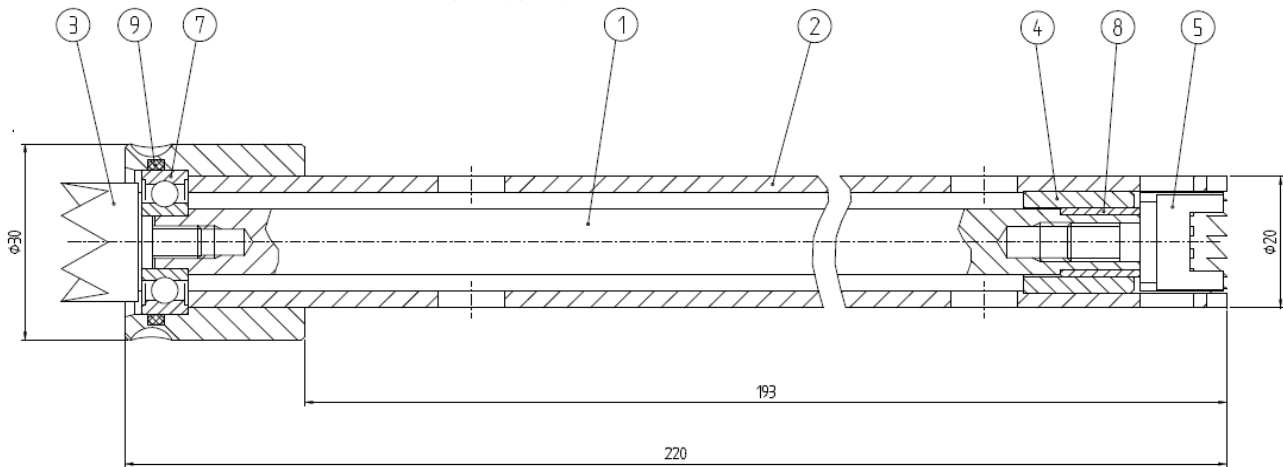

1. Fix the crown head (3) using the tool. Unscrew the rotor (5) using a suitable tool. Pull out the shaft (1) of the stator tube.
2. Remove the o-ring (9) out of the groove.
3. Unscrew the crown head from the shaft.
4. After the cleaning process, reassemble the aggregate in reverse order.

4.2.3 Disassembly of Dispersing-Aggregates with $\varnothing 30+$.

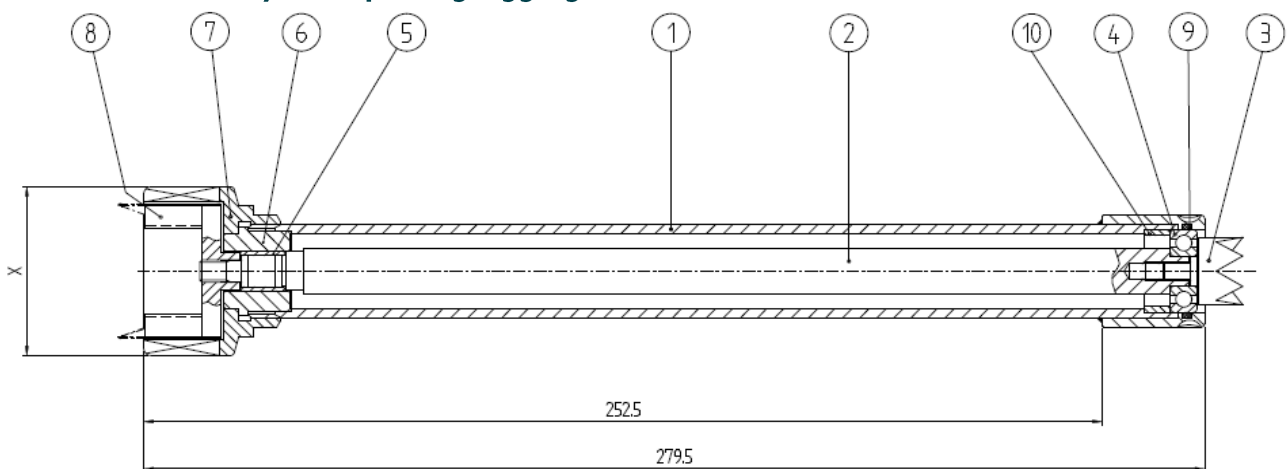

1. Fix the crown head (3) using the tool. Unscrew the rotor (8) using a suitable tool. Pull out the shaft (2) of the stator tube.
2. Unscrew the stator (7).
3. Pull out the shaft (2) of the stator tube (1).
4. Remove the o-ring (9) out of the groove.
5. Unscrew the crown head (3).
6. After the cleaning process, reassemble the aggregate in reverse order.

Operating Manual			
System	POLYTRON®		
Typ	PT 45-80 GT		
Ausgabe	1.0 / 01.06.2019		
Seite	29	von	33

4.2.4 Criteria for changing bearings

Basically, it is the operating company that determines when and how often the bearings are to be changed. They should, however, be changed at the latest if:

- rotor and stator are touching
- there is an increase in vibration,
- the rotor projects above the edge of the stator.

For a replacement of the ball bearings please contact a certified KINEMATICA service center or KINEMATICA directly.

Any unauthorized modification or manipulation of the unit or its equipment leads to immediate annulment of the warranty.

Operating Manual			
System	POLYTRON®		
Typ	PT 45-80 GT		
Ausgabe	1.0 / 01.06.2019		
Seite	30	von	33

System	POLYTRON®		
Typ	PT 45-80 GT		
Ausgabe	1.0 / 01.06.2019		
Seite	30	von	33

5 TROUBLE SHOOTING

PROBLEM	REASON	CORRECTIVE MEASURES
Unusual noises	Damaged drive bearings	Change ball bearings. Trace & replace defective parts (shaft, bearings)
	Damaged aggregate bearings	Change bearings
	Rotor/stator interference	Trace and replace defective parts (shaft, bearings)
Drive automatically stops & an alternating beeping sound is audible and the message "HO" is shown on the display	Inadequate ventilation	Check if ventilation slots are clear. Cool down the device & restart
	Thermal overload	Check manner of use. Cool down the device & restart.
Vibrations	Bent shaft	Replace shaft
	Worn bearing(s)	Replace bearing(s)
	Defective coupling	Trace and replace defective parts
Drive does not start respectively suddenly stops. A constant beeping sound is audible and the message "BL" is shown on the display	Defective internal control	Send the equipment to the nearest authorised KINEMATICA service centre or directly to KINEMATICA AG
	Drive is blocked	Check the aggregate for solid particles which may be blocking the rotor, remove the particles, turn off the drive and restart operation.

Operating Manual			
System	POLYTRON®		
Typ	PT 45-80 GT		
Ausgabe	1.0 / 01.06.2019		
Seite	31	von	33

6 ACCESSORIES

A large selection of special homogenizing vessels is available, which can improve the efficiency of the processing of your product. Closed vessels to withstand vacuum or pressure can also be supplied.

Ask your dealer or contact Kinematica directly.

Operating Manual			
System	POLYTRON®		
Typ	PT 45-80 GT		
Ausgabe	1.0 / 01.06.2019		
Seite	32	von	33

7 WARRANTY

KINEMATICA AG guarantees that the equipment that it produces will run free of any fault related to materials or manufacturing faults for 24 months.

ADDITIONAL WARRANTY FOLLOWING REGISTRATION

Consumers who complete a warranty registration within 20 days of receiving their device will benefit from a free warranty extension of a further 12 months. This means that the total warranty period after registration is 36 months.

REGISTER NOW



kinematica.ch/warranty-upgrade

If thorough testing shows a fault to be due to either of the above causes, KINEMATICA AG guarantees that the equipment will be repaired or replaced free of charge. The guarantee does not cover parts that are subject to normal wear. It is void if any person other than an employee of KINEMATICA AG or their appointed representative has made modifications to the equipment or if the damage is due to failure to comply with the operating instructions, to carelessness, accident, incorrect use or incorrect supply voltage.

Please check our further warranty conditions and the correct procedure for a repair application on our website:

<http://www.kinematica.ch/en/contact-service/service-and-repair.html>

KINEMATICA AG reserves the right to make technical changes to the equipment without modifying equipment delivered earlier in the same way.

In the event of technical problems, for spare parts requirements or for advice, contact our regional appointed agent, your preferred dealer or us directly at:

KINEMATICA AG

Werkstrasse 7, C-D
CH-6102 Malters
Switzerland

Tel. +41-41-259 65 65
Fax +41-41-259 65 75
Email service@kinematica.ch

Operating Manual

System	POLYTRON®		
Typ	PT 45-80 GT		
Ausgabe	1.0 / 01.06.2019		
Seite	33	von	33

8 DISPOSAL



The symbol of the crossed refuse container signifies that the product in the European Union to must be supplied to separate collection. Labeled products must not be disposed with household waste, rather must be left at a collection point for recycling electrical and electronic equipment. Recycling helps to reduce the consumption of raw materials and to protect the environment.